



NEW WTMDs IP66
CONTROL UNIT

PMD2 Plus

ENHANCED WALK-THROUGH MULTI-ZONE METAL DETECTOR

KEY FEATURES

- Superior Detection and Throughput
- High Discrimination of Non-Threat Items
- Exceptional Immunity to external interferences
- Compliant with the strictest Security Standards for weapons detection
- New mechanical structure with high protection degree
- Unmatched Reliability
- Aesthetic, Unobtrusive and Light Weight
- Rapid Installation

COLUMN AND PANEL VERSIONS AVAILABLE



GSA Contract Holder

www.ceia-usa.com

THREAT DETECTION THROUGH ELECTROMAGNETICS



Strict requirements and detection needs call for security checkpoints to perform efficiently even under very challenging conditions.

The **PMD2 Plus detects firearms and knives**, even when they are **hidden within body cavities**, and accurately indicate the position of the threat, its intensity and its prevalent composition.

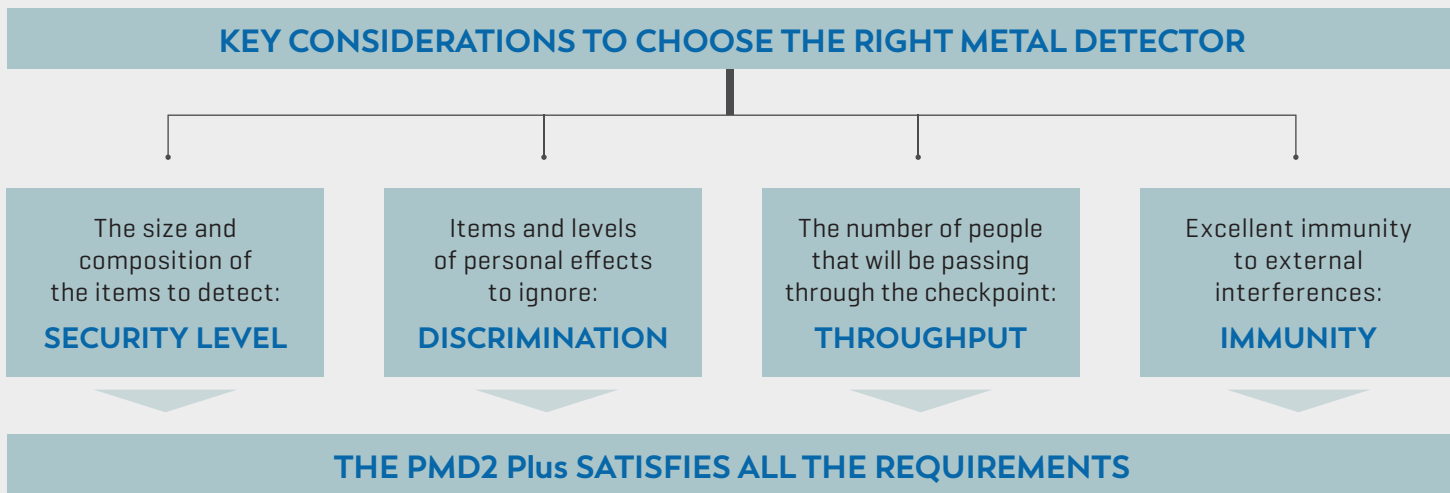

MOST POWERFUL AND VERSATILE SECURITY FEATURES

- Up to 50 built-in Security Programs
 - ▶ Up to 30 International Standards
 - ▶ Up to 20 Customizable Levels

Setting the Security Levels could not be easier and more versatile than in the PMD2 Plus.

Users can choose directly from the known International Standards or request implementation of a Standard personalized to their own requirements. Users can also create their own program and save it in internal memory for later use.



- Chip Card system for fast, simple and secure parameter changes (i.e. alarm volume and tone, counter reading, etc.) and security level selection.
- Any security standard can be enhanced with selectable random alarm probability

CHIP CARD SYSTEM

The system allows Security Management to **set the Security Level quickly, reliably and without having to program the device in any way.**



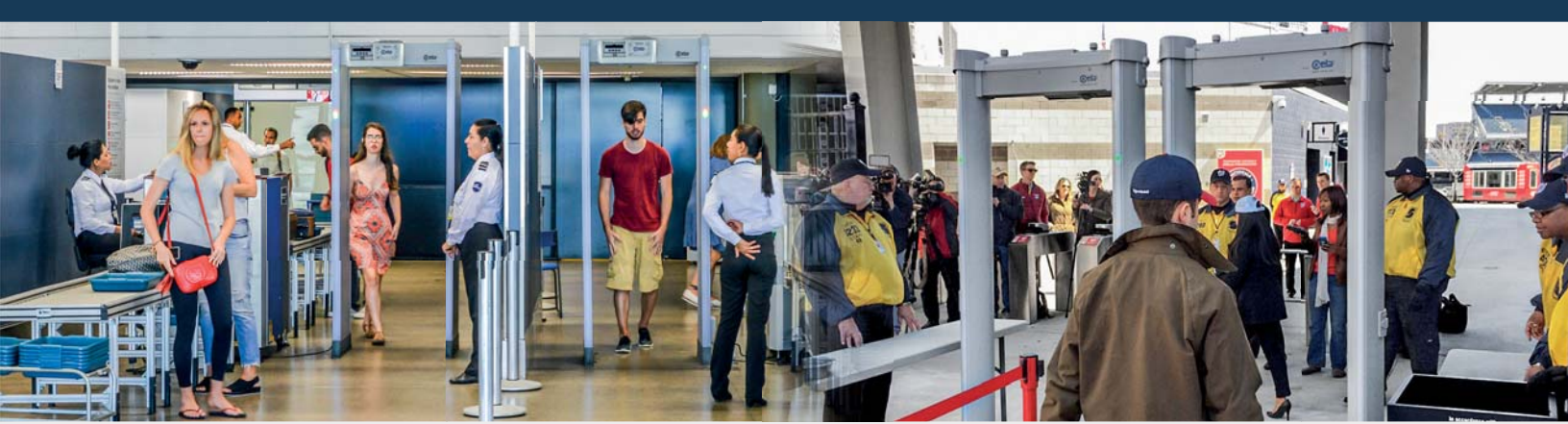

DETECTION OF ALL METALLIC THREAT ITEMS

- Capability to detect the full range of metal weapon threats even within body cavities
- Quick, accurate analysis of all parts of the body of people in transit, from the shoe level to the crossbar
- Guaranteed coverage for all orientations and locations, never in need of calibration
- Met-Identity technology for Identification of Threat Composition



HIGH DISCRIMINATION & THROUGHPUT

- Cutting-edge discrimination technology allows personal effects to be ignored, creating rapid transit flow
- No need to remove items such as belts, coins, keys, jewelry, watches, wallets, etc.
- Better Discrimination = Shorter Lines and Less Staffing

The PMD2 Plus has a **very low nuisance alarm rate even at the strictest Security Standards** requested today, and therefore allows high transit flow rates and the minimum need for intervention by inspection personnel.

ALARM



NO ALARM



IMMUNITY TO EXTERNAL INTERFERENCES

- Exceptional immunity to environmental interferences makes the Metal Detector easy to use even when electrical noise is encountered

60 LOCALIZATION ZONES

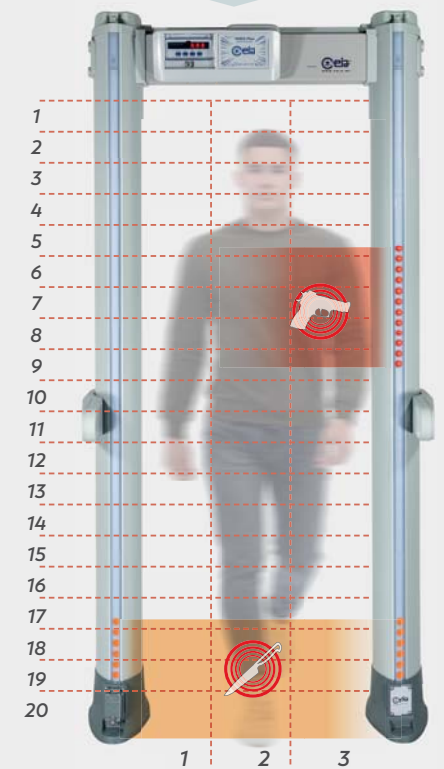

60 Localization zones (20 vertical x 3 lateral) with left, center and right indication.

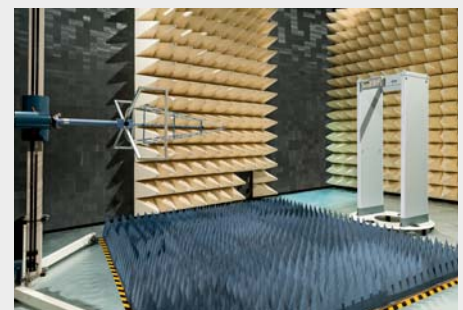



UNIFIED CONSTRUCTION
FOR **INDOOR** AND
OUTDOOR USE



NEW CERTIFIED IP66 CONTROL UNIT

- Total compatibility with previous IP20 (plastic) and IP65 (stainless steel) control units
- Robust structure through the use of high-performance polymers for the construction of housing
- Waterproof / Dustproof: IP66 compliant (IEC 60529)
- Exceptional impact resistance at low and high temperatures and resistance to corrosion from atmospheric agents
- Display made with specific polymer to improve the visibility of the LEDs by increasing the definition and clarity



UNIQUE ALARM SIGNALING

- High visibility of the control unit and of the zone indication, independent from the operator position and the installation environment
- Flexible Acoustic Alarm Signaling System:
 - ▶ 10 Continuous and Pulsed Tones
 - ▶ 34 Special Sounds
- 10 Alarm Volume Levels
- Very High Precision Transit Counter
 - ▶ In-Bound, Out-Bound transits
 - ▶ Alarm Rate
 - ▶ Automatic Compensation for repeated transits of the same person

4 MULTI-ZONE DISPLAY BARS

Light bars indicate metal position vertically and laterally and can also show pacing lights.



HIGH PRECISION TRANSIT COUNTER

- ✓ In-Bound & Out-Bound Transits
- ✓ Alarm Rate
- ✓ Automatic Compensation for repeated transits of the same person



RAPID INSTALLATION

- One touch guided automatic installation (OTS)
 - ▶ Innovative function assisting the installation through an automatic step-by-step procedure
- Continuous self diagnostics assures monitored performance reliability



PMD2 PLUS MODEL SELECTION





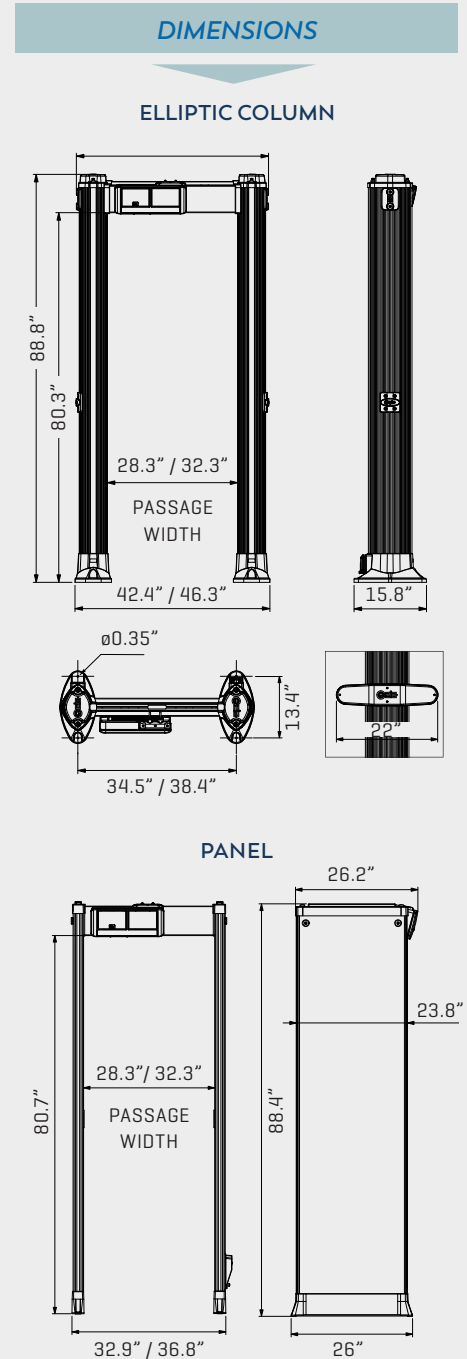

STANDARD CONFIGURATION	PMD2 Plus/EZ	PMD2 Plus/PZ
GATE - SHAPE	ELLIPTIC COLUMN	PANEL
Compliant with the strictest detection and discrimination standards for Enhanced Metal Detectors	●	●
4 display bars each programmable as zone indicators and/or pacing lights	●	●
60 localization zones (20 vertical x 3 lateral)	●	●
Antivandalic and Antitampering IP66 Control Unit	●	●
Weatherproof gate compliant with IEC 60950-22	●	○
Transit counter	○	●
Chip Card Reader	●	●
BT, infrared and RS-232 communication	●	●
Programmable Random Alarm capability	●	●
3-Level Password and hardware key access protection	●	●
Met-Identity technology	●	●
One Touch Automatic Self Installation (OTS)	●	●
Automatic Operational Functional Verification (OFV)	●	●
Automatic Vibration Compensation (AVS, EVA)	●	●
Automatic Channel Search (CS)	●	●
Automatic Floor Gain Adjustment (FGA)	●	●
Automatic Technical Functional Verification (TFV)	●	●
Automatic Environmental Noise Compensation (ENA)	●	●
Powered by safe low voltage DC	●	●
Anti-tamper on/off switch	●	●

COMMUNICATION CAPABILITIES					
TYPE OF OPERATION	ETHERNET	USB	INFRARED	BT	RS-232
MAINTENANCE	○	○		●	●
REMOTE CONTROL	○		●	●	●
REMOTE DATA COLLECTION	○				







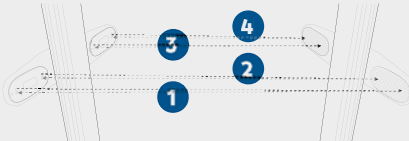

STANDARD ● OPTION ○



OPTIONS

OPTION	DESCRIPTION		CODE
<p>IP65 CONFIGURATION</p>	<p>Outdoor sheltered permanent or non-sheltered short-term installations [single event entrance]. This kit includes shelters, and protection covers for power supply.</p>		<ul style="list-style-type: none"> • 28.3" passage width [102710] • 32.3" passage width [102712]
<p>EMBEDDED BATTERY BACK-UP AND CHARGER</p>	<p>Lower Connection Module with anti-tamper on/off switch, RS-232 interface and internal battery back-up. The module provides an audible 'flat battery' signal activated when the battery charge goes below the operational limit of the device [signal endurance: about 12 hours].</p>		<p>PANEL: APSM2Plus/P</p>
<p>APSiM2 PLUS Integrated Web-server & Logger, Battery Back-up and Charger</p>	<p>Lower Connection Module with anti-tamper on/off switch, RS-232 interface, internal battery back-up and the following functions:</p> <ul style="list-style-type: none"> ▶ Built-in 10/100 base T Ethernet LAN interface ▶ Web server for set-up and remote data log ▶ Real/Time clock with battery backup ▶ Non-volatile Memory for Metal Detector events storage 		<p>PANEL: APSiM2Plus/P</p>
<p>APSiM2 PLUS Integrated Web-server & Logger</p>	<p>Anti-tamper on/off switch, RS-232, USB, 10/100 baseT Ethernet interface, data logger, real-time clock, integrated web-server, statistical transit data analysis.</p>		<p>ELLIPTIC: APSiM2Plus/E</p>
<p>APSiM3 PLUS Wireless Network Module</p>	<p>Includes all features and characteristics of the APSiM2 Plus with additional:</p> <ul style="list-style-type: none"> ▶ Wi-Fi communication capability ▶ Compatibility with NetID Management software [NetID software license not include] 		<p>ELLIPTIC: APSiM3Plus/E PANEL: APSiM3Plus/P</p>
<p>32.3" USEFUL PASSAGE WIDTH</p>			<p>ELLIPTIC: 55664 PANEL: 55635</p>
<p>HIGH PRECISION TRANSIT COUNTER (2-BEAM)</p>	<p>Two photocells fitted into the archway allow counting of transits, alarms and percentage of alarms</p>		<p>ELLIPTIC: 46982</p>
<p>VERY HIGH PRECISION TRANSIT COUNTER (4-BEAM)</p>	<p>The 4-beam version further increases accuracy in counting and determination of transit direction, even in intense transit conditions.</p>		<p>ELLIPTIC: 46983</p>

ACCESSORIES







ACCESSORY	DESCRIPTION	CODE
CHIP CARDS	Chip cards for simple and secure selection of Security Levels and parameter setting. List of chip-cards available on request.	
MD-WHK	Wireless repeater of acoustic indications for WTMDs.	MD-WHK
CROSSBAR BATTERY BACK-UP	<ol style="list-style-type: none"> Crossbar battery back-up in stainless steel case. Up to 10 h of autonomous working time. Protection cover 	 <p>PANEL: 55681 PROTECTION COVER: • 28.3" passage width: 88858 • 32.3" passage width: 88861</p>
	<p>The battery pack is embedded into the crossbar of the archway. Typical operating time in battery mode is 7 hours.</p>	 <p>ELLIPTIC: • 28.3" passage width: 74699B • 32.3" passage width: 89609</p>
UPPER PROTECTION COVER	Additional outdoor protection to further improve the IP65 protection rating	 <p>ELLIPTIC: • 28.3" passage width: 102713 • 32.3" passage width: 102714</p>
SUPPLY UNIT SERIES	<ol style="list-style-type: none"> MBSU LWSC (Light Weight Soft Case Version) MBSU-2 TSU (Tactical supply unit) 	 <p>MBSU LWSC</p>
	<p>Portable and compact battery back-up units and charger designed to supply DC voltage to CEIA equipment where mains is not available or as Uninterruptable Power Supply unit (UPS) in installations requiring continuous operations.</p> <p>TYPICAL CONTINUOUS OPERATION</p> <ul style="list-style-type: none"> MBSU LWSC: 14h MBSU-2: 14h TSU: 4 battery pack: 12h / 6 battery pack: 17h / 8 battery pack: 23h 	 <p>MBSU-2</p>
		 <p>TSU</p>
RRU	Remote relay unit (RRU) to repeat the detection alarms of the gate through a relay contact. The RRU module can be used for integration of the Metal Detector in interlocked door systems. An additional relay is available for a customer-specified application.	RRU-2
IRC-1	Infrared Remote Controller for wireless remote programming of the control unit.	 <p>47180</p>
UPPER CONNECTION MODULE	This module along with an extension cable allows the connection of power supply and serial communication to personal computers or CEIA accessories.	<ul style="list-style-type: none"> • 46650 • 7": 89040 • 16.4 ft: 95352
TOP POWER CABLE	This cable allows the AC/DC adapter to be connected to PS/COM port located on top of the TX antenna to supply the Metal Detector Gate.	 <ul style="list-style-type: none"> • 32.8 ft: 64228 • 65.5 ft: 68346

CEIA USA reserves the right to make changes, at any moment and without notice, to the models (including programming), their accessories and options, to the prices and conditions of sale.







ACCESSORIES



VISUAL ALARM WITH ZONE INDICATION

ACCESSORY	DESCRIPTION		CODE
<p>RCU2</p>	<p>Control unit for full remote access, including alarm signalling and programming of CEIA Metal Detectors. The connection is performed via serial cable connection or via BT [option].</p>		<p>RCU2</p>
<p>MD-SCOPE</p>	<p>Powerful, PC based installation and service Software. Includes oscilloscope and terminal functionality. The connection is performed via BT [standard] or via cable connection.</p>		<p>MD-SCOPE2</p>
<p>WHEEL KIT - LONG RANGE</p>	<p>For heavy duty, longer range movement of the walk-through metal detector.</p> 		<p>ELLIPTIC: 70569 PANEL: 70796</p>
<p>WHEEL KIT - SHORT RANGE</p>	<p>For short range movement of the walk-through metal detectors.</p> 		<p>ELLIPTIC: 77318 PANEL: 75459U</p>
<p>ELLIPTIC GATE PROTECTIVE COVER</p>	<p>Protects the gate in permanent outdoor installations during periods of inactivity:</p> <ul style="list-style-type: none"> • Long life product, heavy duty material and construction, welded cloth, seamless • Foldable, small dimensions • Tear resistant • Easy to clean • Anti-vandalism deterrent • Anti-tampering - lockable <p>Open the link to see video: www.ceia.net/security/EllipticGateProtectiveCover.aspx?lan=us1</p>		<p>ELLIPTIC GATE:</p> <ul style="list-style-type: none"> • 28.3" passage width: 64395 • 32.3" passage width: 76609 <p>ELLIPTIC GATE WITH PHOTOCELL ARMS:</p> <ul style="list-style-type: none"> • 28.3" passage width: 76520 • 32.3" passage width: 76610

ACCESSORIES

ACCESSORY	DESCRIPTION		CODE
<p>INTEGRATED CAMERA SYSTEM</p>	<p>Video camera with support arm and connecting cables. Installation of the APSIM3 Plus module is required.</p>		<p>ELLIPTIC: 56110 PANEL: 54253</p>
<p>TDU Thermal Detection Unit</p>	<p>The TDU (Thermal Detection Unit) is an upgrade sensing kit for COVID screening compliance:</p> <ul style="list-style-type: none"> 1 Thermal Camera Arm 2 Dual Reference Calibration Unit 3 Transit counter (not needed if already installed on the gate) 		<p>ELLIPTIC</p> <ul style="list-style-type: none"> • TDU/E 1 + 2 • 4-Beam Transit counter: 46983 3 <p>PANEL</p> <ul style="list-style-type: none"> • TDU/P 1 + 2
<p>METAL DETECTOR DIVESTING TABLE</p>	<p>In combination with CEIA Walk-Through Metal Detectors, it is a temporary location of personal metal effects for people to be screened:</p> <ul style="list-style-type: none"> 1 Standard length: 24" 2 Extended length: 47" 3 Outdoor version: 51" 		<p>STANDARD: 18074 EXTENDED: 39491 OUTDOOR: 67021U</p>
<p>STABILIZING PLATES</p>	<p>Comfortable alternative to direct floor mounting for uneven floor and mobile applications:</p> <ul style="list-style-type: none"> 1 Metal anchoring plate 2 Anti-tilting metal plate 		<p>METAL ANCHORING PLATE: 64355 ANTI-TILTING METAL PLATE: 70914</p>
<p>TOOL-FREE ASSEMBLY KIT</p>	<p>This accessory allows the detector to be assembled and disassembled quickly and without tools.</p>		<p>ELLIPTIC: 55699</p>
<p>TEST SAMPLES KIT</p>	<p>Reference Samples for accurate verification of the Security Level. Includes guided procedures and certificate of calibration</p>		<p>EMD-SK-GAL EMD-SK-GDML</p>
<p>OFV</p>	<p>Operator Functionality Verification test-kit</p>		<p>OFV-KITCASE</p>

NetID ANYWHERE™

WALK-THROUGH METAL DETECTOR MANAGEMENT SYSTEM



NetID Anywhere is a cloud-based systems management solution

for CEIA walk-through metal detectors (WTMD) that centralizes access to important statistics, automates monitoring of critical calibration parameters.



MONITOR

- Monitor WTMD status and settings
- Avoid accidental or unwanted setting changes
- Email notification for critical events or changes
- Logs for every event or change in the WTMDs
- Advanced diagnostics capability

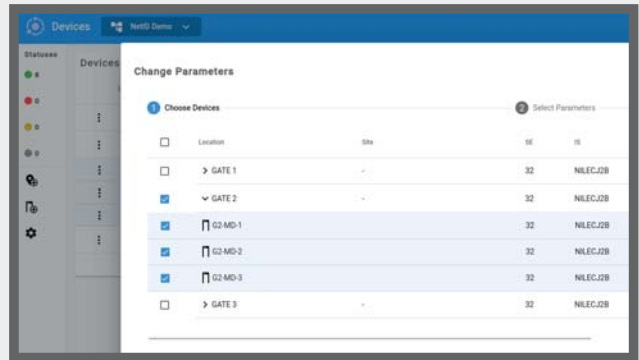

REPORT

Data is collected and retained for each metal detector, including number of transits and metal alarms, allowing analysis of transit flows and alarm rate trends



NETWORKING

- No software to install
- No Infrastructure required
- Easy to install and integrate
- Secure
- Scalable
- Easy to Use, Limited Training Required
- Technical support and software updates included

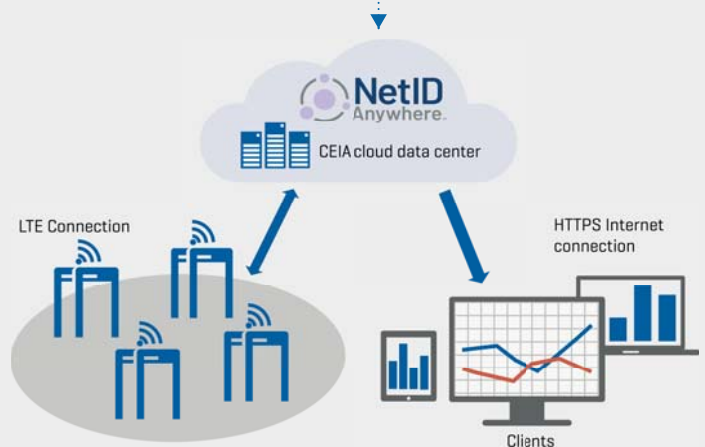

SPECIFICATIONS

GATE STRUCTURE	State-of-the-art, robust and washable panels or compact elliptical columns Protected against aging, weather and wear
OPERATIONAL FEATURES	High discrimination and transit flow rates five or more times greater than other metal detection systems Quick reset time as short as 0.2 seconds for high throughput rate Very high detection speed [up to 50" ft/sec.] Built-in operational functional verification One-touch key reading of inbound, outbound and Security Level Data
QUALITY	Continuous self diagnostic system Proven reliability No periodic re-calibration and preventive maintenance required No scheduled maintenance Fully digital design
ALARM SIGNALING	Multi-zone display bar for "height on person" localization 4 light bars with selectable entry/exit and pacing indication Green and red metering signals proportional to the mass of the detected target 10 selectable continuous and pulsed tone plus 34 special tones 10 selectable sound intensities ranging from 0 to 90 dbA at 3.3 ft
TYPE OF SIGNALING	Fixed or proportional to the mass in transit - visible from 19.7 ft under lighting of 4000lux 60 distinct zones [20 vertical x 3 lateral] entry and exit side
PROGRAMMING	Up to 50 built-in Security Programs Remote via Infrared Remote Control Unit, BT or Ethernet 10/100 base T [option] interface Security level: International Standard [IS] command / Chip card Local by Control Unit alphanumeric display and keyboard Programming and chip card access protected by user and super-user passwords
ENVIRONMENTAL DATA	Power Supply : 100...277V~ ±10%, 47...63Hz, 40 VA typical consumption Operating temperature: -4°F to 149°F [-34°F to 158°F upon request] Storage temperature: -34°F to 158°F Relative humidity: 0 to 95% [without condensation]
INSTALLATION DATA	Automatic synchronization between two or more metal detectors with distance of down to 2" without the use of external cables Automatic Installation function [OTS]

CERTIFICATION AND COMPLIANCE

- Compliant with and certified to the applicable Standards for Enhanced Metal Detectors [EMD]
- Compliant with the applicable electromagnetic Standards on Human Exposure and Pacemaker Safety
- Compliant with all Airport Security Standards worldwide
- Compliant with applicable International Standards for electrical safety and EMC

APPLICATIONS

- GOVERNMENT BUILDINGS
- AIRPORTS
- INDUSTRIES
- NUCLEAR FACILITIES
- PRISONS (VISITORS)
- PUBLIC EVENTS
- AMUSEMENT PARKS
- COURTS
- CRUISE SHIPS
- DATA PROCESSING CENTERS (EDP)
- HOTELS
- SCHOOLS SECURITY

COMPREHENSIVE SUPPORT

CEIA USA PROVIDES FULL OPERATIONAL AND TECHNICAL TRAINING SUPPORT BY CERTIFIED PERSONNEL EITHER AT CEIA FACILITY OR AT CUSTOMER LOCATION.



PMD2 PLUS - ENHANCED WALK-THROUGH MULTI-ZONE METAL DETECTOR



CEIA USA Ltd - 6336 Hudson Crossing Parkway, Hudson OH 44236

P 330-405 3190 • **F** 330-405 3196 • **E** security@ceia-usa.com • **CALL** (833) 224-2342 (CEIA)

www.ceia-usa.com

CEIA USA reserves the right to make changes, at any moment and without notice, to the models (including programming), their accessories and options, to the prices and conditions of sale. DP060K0093v1000uUS (2021)